

CONSERVATOR®

USE & CARE GUIDE

Model No VATM05B1

5,000 BTU Window Air Conditioner



Pay Less, Save More with Conservator

www.conservatorappliances.com

INTRODUCTION

IMPORTANT SAFETY INSTRUCTION	1
ELECTRICAL REQUIREMENTS	3
PACKING LIST	4
INSTALLATION&ASSEMBLY INSTRUCTIONS	5
USING YOUR AIR CONDITIONER	10
CARE AND CLEANING	11
TROUBLESHOOTING	12

IMPORTANT SAFETY INSTRUCTIONS

Before installing and using your air conditioner, please read this owner's manual carefully. Store this manual in a safe place for future reference. Your safety and the safety of others is very important to us. Please pay attention to all safety messages outlined in this owner's manual.

WARNING: To reduce the risk of fire, electrical shock or injury when using your air conditioner, follow the following basic precautions:

- Plug into a grounded 3 prong outlet.
- Do not remove the ground prong.
- Do not use a plug adapter.
- Do not use an extension cord.
- Unplug the air conditioner before servicing
- Use two or more people to move and install the air conditioner



This is a safety alert symbol.

This symbol alerts you to potential hazards that can harm you or others or even cause death.

All safety messages will directly follow the safety alert symbol and/or the words "DANGER" or "WARNING".

⚠ DANGER

⚠ WARNING

Failure to immediately follow these instructions may cause serious injury or even death.

All Safety messages alert you of potential hazards, how to reduce the chance of injury, and what can happen if instructions are not followed correctly.

INTRODUCTION TO REFRIGERANTS R32

The refrigerants used for air conditioners are environmentally friendly hydrocarbons R32. This kind of erant is combustible and odorless. Moreover, it can burn and explode under certain condition. However, there will be no risk of burning and explosion if you comply with the following table to install your air conditioner in a room with an appropriate area and use it correctly.

Compared with ordinary refrigerants, Refrigerant R32 is environmentally friendly and do not destroy the ozone sphere and that its value of greenhouse effect is also very low.

Room area requests for air conditioner with Refrigerant R32

Refrigerant	Capacity(Btu)	Room Area
R32	≤9K	Above 4m ²
	≤12K	Above 4m ²
	≤18K	Above 15m ²
	≤24K	Above 25m ²

Warnings

- Please read the manual before installation, using, maintenance.
- Do not use means to accelerate the defrosting process or to clean, other than those recommended by the manufacturer.
- Do not pierce or burn the appliance.
- The appliance shall be stored in a room without continuously operating sources (for example: open flames, an operating ignition gas appliance or an operating electric heater.)
- Please contact the nearest after-sale service center when maintenance is necessary. At the time of maintenance, the maintenance personnel must strictly comply with the Operation Manual provided by the corresponding manufacturer and any non-professional is prohibited to maintain the air conditioner.
- The handling, installation, storage, servicing and disposal must comply with the provisions of gas-related national laws and regulations, and also national wiring regulation.
- It is necessary to clear away the refrigerant in the system when maintaining or scrapping an air conditioner. Be aware that refrigerants may not contain an odour.

This appliance is not intended for use by persons (including children) with reduced physical, sensory or mental capabilities, or supervision or instruction concerning use of the appliance by a person responsible for their safety.

Children should be supervised to ensure that they do not play with the appliance.

Unit operation limits: Outdoor side 61~110°F, 80%RH; indoor side 61~90°F, 80%RH.



ELECTRICAL REQUIREMENTS

⚠ WARNING



Electrical Shock Hazard

Plug into a grounded 3 prong outlet.
Do not remove the ground prong.
Do not use an adapter
Do not use an extension cord.
Failure to follow these instructions can result in death, fire, or electrical shock

The electrical ratings for your air conditioner are listed on the model and serial number label located on the front left side of the unit (when facing the front).

Specific electrical requirements are listed in the chart below. Follow the requirements below for the type of plug on the power supply cord.

Wiring Requirements

- 115 volt (103 min.—127 max)
- 0-8 amps
- 10-amp time-delay fuse or circuit breaker
- Use on single outlet circuit only

Power Supply Cord

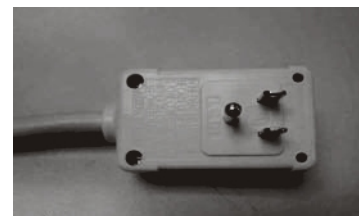

Recommended Ground Method

For your personal safety, this air conditioner must be grounded. This air conditioner is equipped with a 3 prong power supply cord with a grounded plug. To minimize the possibility of electrical shock, the cord must be plugged into a 3 prong outlet and grounded in accordance with all local codes and ordinances. If a 3 prong outlet is not available, it is the customer's responsibility to have a properly grounded 3 prong outlet installed by a qualified electrician.

It is the customer's responsibility:

- To contact a qualified electrician
- To assure that the electrical installation is adequate and in conformance with the National Electrical Code, ANSI/NFPA 70 - latest edition, and all local codes and ordinances.

Copies of the standards listed may be obtained from:

National Fire Protection Association
One Batterymarch Park
Quincy, Massachusetts 02269

LCDI Power Cord and Plug

This air conditioner is equipped with an LCDI (Leakage Current Detection and Interruption) power cord and plug as required by US National Electric Code 440.65. This cord consists of a length of shielded flexible cord with no termination on the load side and a LCDI attachment plug on the line side.

The LCDI power cord and plug will remove the supply source via electrical disconnect (circuit trip) if the nominal current leakage between the cord shield and either load conductor exceeds a predetermined value. The cord will remain de-energized until the device has been manually reset. This is intended to reduce the risk of a fire in the power cord or combustible materials nearby. The cord shields are not grounded and they must be considered a shock hazards if exposed. The cord shield must not be connected to ground or to any exposed metal.

The test and reset buttons on the LCDI Plug are used to check if the plug is functioning properly. To test the plug:





1. Plug power cord into a wall outlet
2. Press the TEST Button, the circuit should trip and cut all power to the air conditioner
3. Press the RESET button for use

If a test is performed and the indicator light remains ON, the current leakage has been detected. Do not use the air conditioner or attempt to reset the LCDI Plug. Contact Customer Service for troubleshooting recommendations.

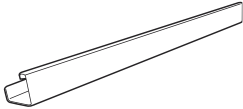
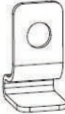
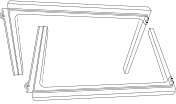

PACKING LIST

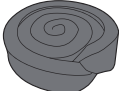
(appearance may vary)

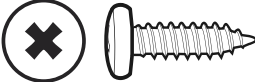
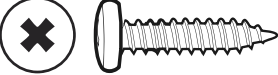
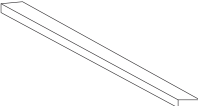
IMAGE	PART	QUANTITY
	Window Air Conditioner	1
	Top Mounting Rail (With sponge)	1
	Lock Frame	2
	Filler Panels (With "Left" & "Right" remark on the front face)	2
	Sash Lock(Two holes)	1
	Window Sash Seal (Sponge)	1
	3/8" Screws	4
	1/2" Screws	3
	3/4" Screws	4
	Foam Top Window Gasket (Thin sponge for back-up using)	1

DISCLAIMER

ALL INFORMATION AND THE TECHNICAL SPECIFICATIONS PRESENTED IN THIS USER'S MANUAL ARE THE PRESENTATION OF THE MANUFACTURER. Crosley Corporation HAS NOT CONDUCTED INDEPENDENT TEST TO THE INFORMATION AND THE SPECIFICATIONS PRESENTED HEREWITHIN.

INSTALLATION & ASSEMBLY INSTRUCTIONS

Some assembly is required for your new air conditioner. Please read and follow these instructions carefully.

1. This air conditioner is designed to be installed in a standard double-hung window with a window width between 23" and 36" (584 mm - 914 mm).
2. The air conditioner can be installed without the accordion panels to fit in a narrow window opening. See the window dimensions.
3. The Lower Sash (the lower part of the window that moves up and down) must allow for 14.5" of vertical clearance when open. (See FIG. 1).
4. All supporting parts must be secured to firm wood, masonry, or metal.
5. The electrical outlet must be within reach of the power cord.

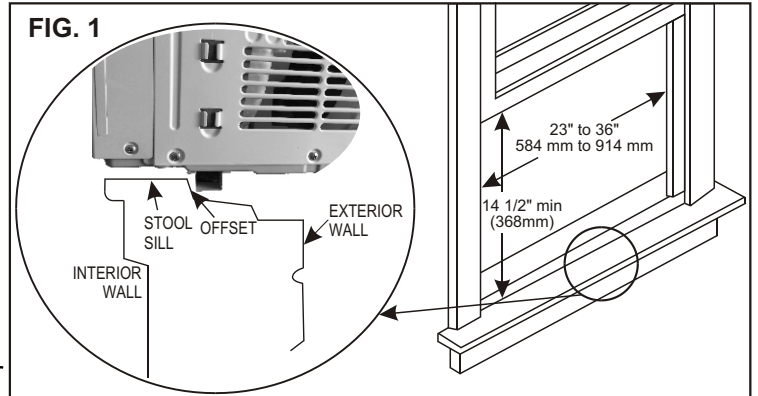



NOTE: Save the product packaging and installation instructions for future reference. Store the air conditioner in the product box when not in use for an extended period of time.

Top Rail Assembly

The top rail must be assembled prior to installing the air conditioner in the window

Tools Needed: Phillips Screw Driver

Top Rail Hardware		QTY
	3/8" Screw	4
	Top Rail	1

Attaching the Top Rail to the Air Conditioner

1. Remove the air conditioner from the box and place on a hard flat surface.
2. Remove top rail from the top of the packaging material as shown in FIG. A
3. Align the hole in the top rail with those in the top of the unit as shown in FIG. B
4. Secure the top rail to the unit with the 3/8" Screws as shown in FIG. C

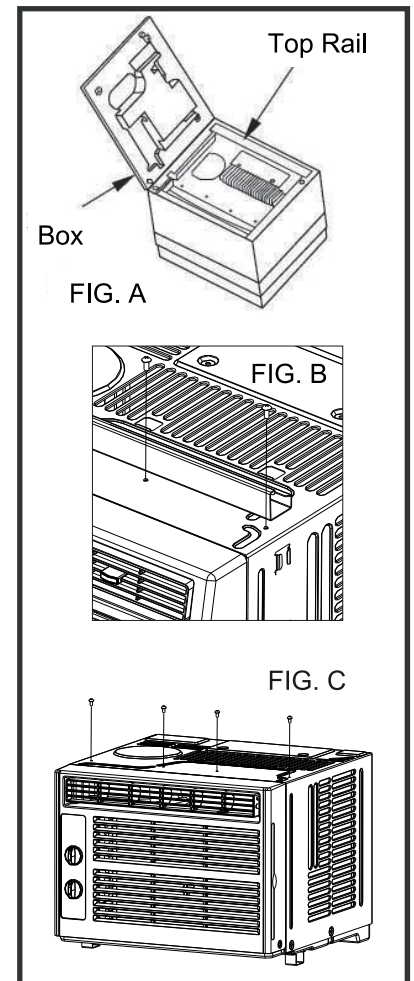

NOTE: For safety reasons, all 4 screws must be used to attach the top rail.

CAUTION

When handling the unit, be careful to avoid cuts from the sharp metal edges and aluminum fins on the front and rear coils.

ASSEMBLY & INSTALLATION (CONT.)

Accordion Panel Installation

Now that you have installed the top rail, you can now install the accordion panels on each side.

1. Place the air conditioner on a hard flat surface.
2. Locate the accordion panels in the box.
3. Gently pull the free end of the accordion panel (See FIG. 2). Do this for both panels.



4. Slide the free end of the accordion panel into the side panel of the air conditioner (See FIG. 3). Do this for each side.



5. Once the accordion panels are slid into place adjust the top and bottom rails of the accordion panels into the top and bottom rails of the air conditioner (See FIG. 4).



Storm Window Requirements

A storm window frame will not allow the air conditioner to tilt properly which in turn will keep it from draining properly. To adjust for this, attach a board or piece of wood to the sill. The board or wood piece should have a depth of at least 1 1/2". Make sure the board or piece of wood is approximately 1/2" higher than the storm window frame. This will allow the air conditioner to tilt enough for proper drainage. (See FIG. 5).

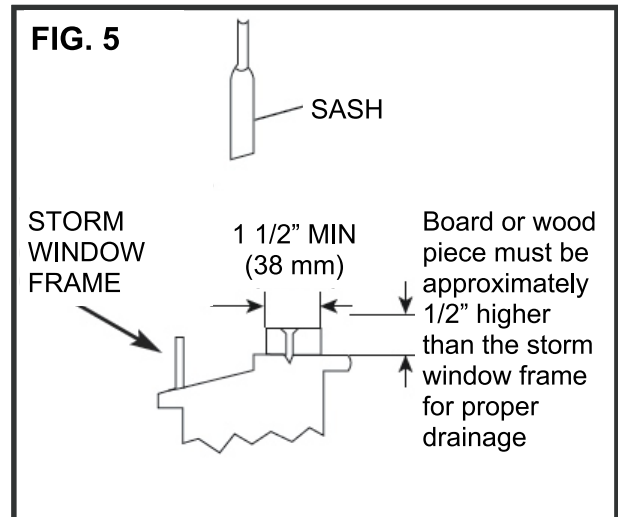

Placing the Unit Inside a Window

1. Place the air conditioner on the sill with the bottom mounting rail against its back edge. Center the air conditioner and close the window securely behind the top mounting rail. The air conditioner should be slightly tilted to the outside area. Use a level; about a 1/3 bubble will be the correct case slant to the outside. (See FIG. 6 & FIG. 7) (**Suggest to keep a downward oblique, to let accumulated rain water to drain out, from back side of the unit bottom.**)

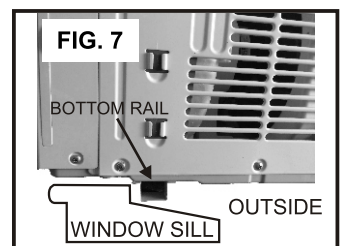
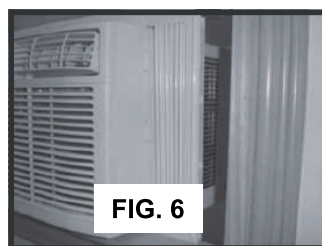

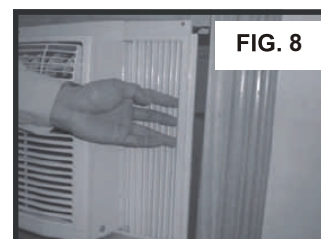

2. Once the air conditioner is placed, extend both the left and right accordion panels to the width of the window.

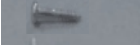

ASSEMBLY & INSTALLATION (CONT.)

Frame Lock, Sash Lock, and Foam Seal Installation

MOUNTING HARDWARE		
	3/4" Screws	Qty 4
	1/2" Screws	3
	Frame Lock	2
	Sash Lock	1

Tools Needed:

Phillips Screw Driver
Drill (if pilot holes are needed)

- Place the frame lock between the extended accordion panels and the window sill as show in FIG. 9. Screw a 3/4" (19 mm) locking screw through the frame lock and into the window sill (FIG. 10).



- Drive 1/2" screws into the top of the accordion panel frame and the top rail to securely attach the window air conditioner to the lower sash. (See FIG. 11/12)

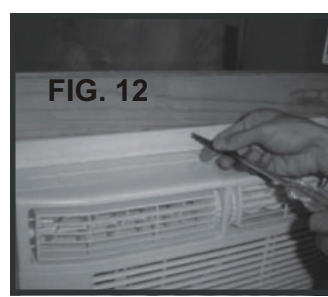
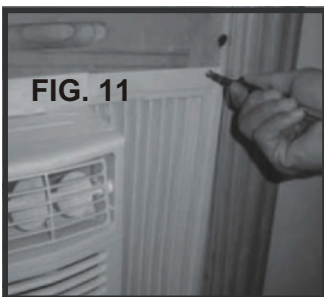

- To secure the lower sash into place, use the sash lock and a 3/4" screw as shown below (See FIG. 13)



- For added insulation, cut the supplied insulation foam to the width of the window. Insert the foam between the window sashes to prevent air and objects from getting into the room. (See FIG. 14)



Removing the Air Conditioner from the Window

- Turn the air conditioner off, and disconnect the power cord.
- Remove the sash seal from between windows, and unscrew sash lock.
- Remove the screws installed through the frame and frame lock.
- Close (slide) the side panels into frame.
- Keeping a firm grip on air conditioner, raise the sash and carefully "rock" air conditioner backward to drain any condensate water in base of unit. Be careful not to spill any remaining water while lifting unit from window.
- Store parts WITH the air conditioner in the box

INSTALLATION & ASSEMBLY INSTRUCTIONS

Introduction to Refrigerants R32

- Before installing the appliance, you must read the manual carefully to get the safety information and notes.
- When filling the combustible refrigerant, any of your rude operations may cause serious injury or injuries to human body or bodies and object or objects.
- A leak test must be done after the installation is completed.
- It is a must to do the safety inspection before maintaining or repairing an air conditioner using combustible refrigerant in order to ensure that the fire risk is reduced to minimum.
- It is necessary to operate the machine under a controlled procedure in order to ensure that any risk arising from the combustible gas or vapor during the operation is reduced to minimum.
- Requirements for the total weight of filled refrigerant and the area of a room to be equipped with an air conditioner (are shown as in the following Tables GG.1 and GG.2)



The maximum charge and the required minimum floor area

$$m_1 = (4 \text{ m}^3) \times LFL, m_2 = (26 \text{ m}^3) \times LFL, m_3 = (130 \text{ m}^3) \times LFL$$

Where LFL is the lower flammable limit in kg/m^3 , R32 LFL is 0.306 kg/m^3 .

For the appliances with a charge amount $m_1 < M \leq m_2$:

The maximum charge in a room shall be in accordance with the following: $m_{\max} = 2.5 \times (LFL)^{(5/4)} \times h_0 \times (A)^{1/2}$

The required minimum floor area A_{\min} to install an appliance with refrigerant charge M (kg)

shall be in accordance with following: $A_{\min} = (M / (2.5 \times (LFL)^{(5/4)} \times h_0))^2$

Where:

m_{\max} is the allowable maximum charge in a room, in kg;

M is the refrigerant charge amount in appliance, in kg;

A_{\min} is the required minimum room area, in m^2 ;

A is the room area, in m^2 ;

LFL is the lower flammable limit, in kg/m^3 ;

h_0 is the installation height of the appliance, in meters for calculating m_{\max} or A_{\min} , 1.8 m for wall mounted;

Table GG.1 Maximum charge (kg)

Category	LFL (kg/m^3)	h_0 (m)	Floor area(m^2)						
			4	7	10	15	20	30	50
R32	0.306	0.6	0.68	0.9	1.08	1.32	1.53	1.87	2.41
		1	1.14	1.51	1.8	2.2	2.54	3.12	4.02
		1.8	2.05	2.71	3.24	3.97	4.58	5.61	7.254
		2.2	2.5	3.31	3.96	4.85	5.6	6.86	8.85

Table GG.2 Minimum room area (m^2)

Category	LFL (kg/m^3)	h_0 (m)	Charge amount (M) (kg)						
			Minimum room area(m^2)						
R32	0.306		1.224 kg	1.836 kg	2.448 kg	3.672 kg	4.896 kg	6.12 kg	7.956 kg
		0.6		29	51	116	206	321	543
		1		10	19	42	74	116	196
		1.8		3	6	13	23	36	60
		2.2		2	4	9	15	24	40

INSTALLATION & ASSEMBLY INSTRUCTIONS

Introduction to Refrigerants R32

1. Site Safety



Open Flames Prohibited



Ventilation Necessary

2. Operation Safety

Open Flames Prohibited



Mind Static Electricity



Must Wear Protective Clothing and anti-static gloves



Don't use mobile phone

3. Installation Safety

- Refrigerant Leak Detector
- Appropriate Installation Location



The left picture is the schematic diagram of a refrigerant leak detector.

Please note that:

1. The installation site should be in a well-ventilated condition.
2. The sites for installing and maintaining an air conditioner using Refrigerant R32 should be free from open fire or welding, smoking, drying oven or any other heat source higher than 548°C which easily produces open fire.
3. When installing an air conditioner, it is necessary to take appropriate anti-static measures such as wear anti-static clothing and/or gloves.
4. It is necessary to choose the site convenient for installation or maintenance wherein the air inlets and outlets of the indoor and outdoor units should be not surrounded by obstacles or close to any heat source or combustible and/or explosive environment.
5. If the indoor unit suffers refrigerant leak during the installation, all the personnel should go out till the refrigerant leaks completely for 15 minutes. If the product is damaged, it is a must to carry such damaged product back to the maintenance station and it is prohibited to weld the refrigerant pipe or conduct other operations on the user's site.
6. It is necessary to choose the place where the inlet and outlet air of the indoor unit is even.
7. It is necessary to avoid the places where there are other electrical products, power switch plugs and sockets, kitchen cabinet, bed, sofa and other valuables right under the lines on two sides of the indoor unit, and also prevent mechanical damage from occurring.

USING YOUR AIR CONDITIONER Manual Control Panel

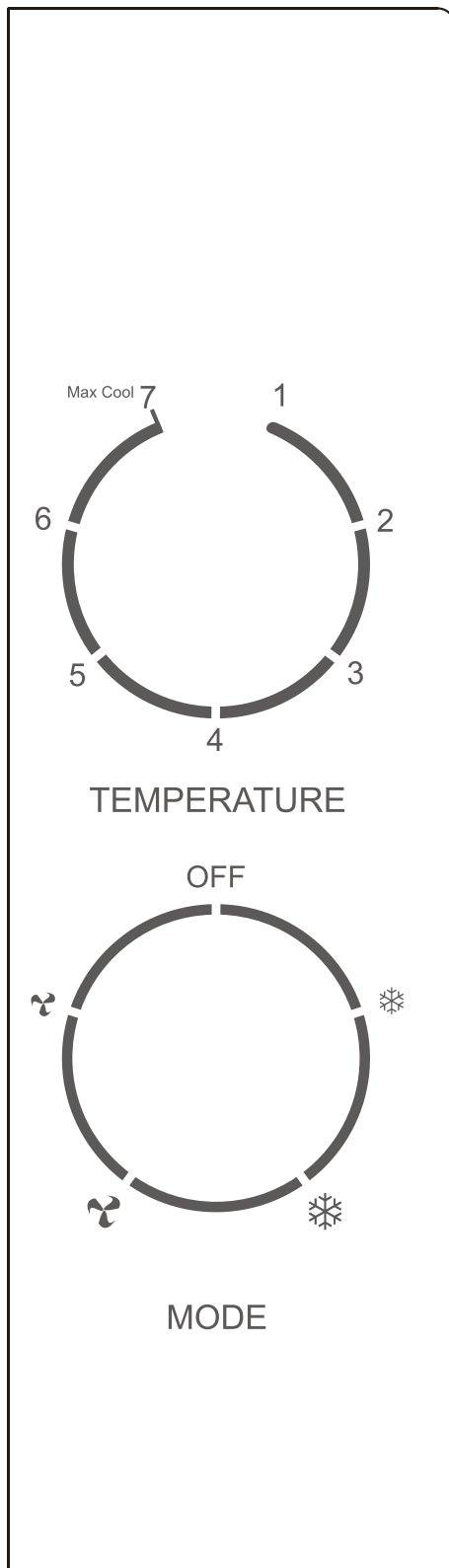

Operating Your Air Conditioner

1. **Power:** Turn on the unit by rotating the MODE dial to the desired setting.
2. **Cooling Mode:** For maximum cooling set the MODE dial to “❄️”. In HIGH COOL mode, the fan will automatically go to high. This will help circulate the cool air throughout the room. The fan will operate on low in “❄️” mode.
3. **Fan Mode:** For fan only modes, choose either “🌀” or “🌀”. The air conditioner will not cool the room when in fan mode.
4. **Thermostat:** Turn the TEMP dial to set the desired room temperature. For maximum cooling turn the TEMP dial to 7 (Max Cool).
5. **Directional Louvers:** To direct the airflow, horizontal wheel to control the horizontal direction, air deflector to control the vertical direction.

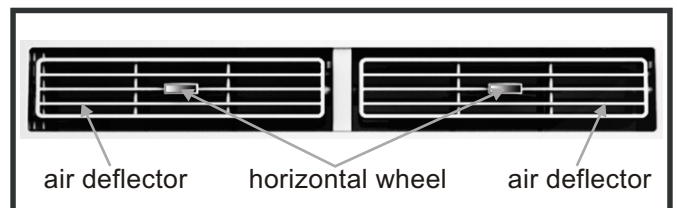

NOTE: To minimize wear and tear on the air conditioner, always wait at least 3 minutes before changing modes. This will help prevent the compressor from overheating and the circuit breaker from tripping.

Normal Operating Sounds

- You may hear a pinging noise caused by water hitting the condenser, on rainy days, or when the humidity is high. This design feature helps remove moisture and improve efficiency.
- You may hear the thermostat click when the compressor cycles on and off.
- Water will collect in the base pan during rain or days of high humidity. The water may overflow and drip from the outside part of the unit.
- The fan may run even when the compressor is not on.

CARE AND CLEANING

Clean your air conditioner to keep it looking new and to minimize dust build up.

Air Filter Cleaning

The air filter should be checked at least once every month to see if it needs cleaning. Trapped particles and dust can build up in the filter and may decrease airflow as well as cause the cooling coils to accumulate frost. To clean the air filter:

1. Remove the filter by sliding it out from the front right side of the air conditioner. (See FIG. 15)
2. Wash the filter using liquid dish soap and warm water. Rinse the filter thoroughly. Gently shake the filter to remove excess water.
3. Let the filter dry completely before placing it into the air conditioner.
4. If you do not wish to wash the filter, you may vacuum the filter to remove the dust and other particles.

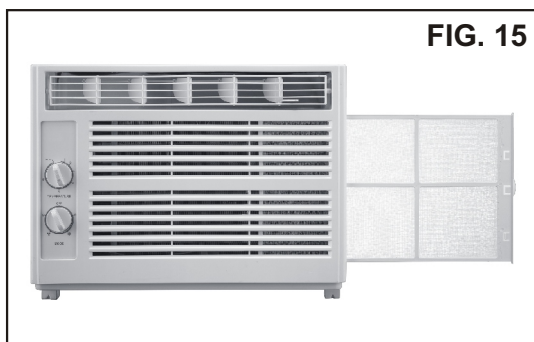

Cabinet Cleaning

To clean the air conditioner cabinet:

- Unplug the air conditioner to prevent shock or a fire hazard. The cabinet and front panel of the air conditioner may be dusted with an oil-free cloth or washed with a cloth dampened in a solution of warm water and mild liquid soap. Rinse thoroughly with a damp cloth and wipe dry.
- Never use harsh cleaners, wax or polish on the cabinet front.
- Be sure to wring excess water from the cloth before wiping around the controls. Excess water in or around the controls may cause damage to the air conditioner.

Winter Storage

To store the air conditioner when it is not in use for an extended period of time, remove it carefully from the window according to the installation instructions and cover it with plastic or place it in the original box.

TROUBLESHOOTING

PROBLEM	POSSIBLE CAUSES	SOLUTIONS
The Air Conditioner will not start	The air conditioner is unplugged	<ul style="list-style-type: none"> Make sure the air conditioner plug is pushed completely into the outlet
	The fuse is blown/circuit breaker is tripped.	<ul style="list-style-type: none"> Check the house fuse/circuit breaker box and replace the fuse or reset the breaker.
	Power failure	<ul style="list-style-type: none"> The unit will automatically re-start when power is restored. There is a protective time delay (approx. 3 minutes) to prevent tripping of the compressor overload. For this reason, the unit may not start normal cooling for 3 minutes after it is turned back on.
	The current interrupter device is tripped.	<ul style="list-style-type: none"> Press the RESET button located on the power cord plug. If the RESET button will not stay engaged, discontinue use of the air conditioner and contact a qualified service technician.
The Air Conditioner does not cool as it should	Airflow is restricted	<ul style="list-style-type: none"> Make sure there are no curtains, blinds, or furniture blocking the front of the air conditioner
	The temperature control may not be set correctly.	<ul style="list-style-type: none"> Turn the TEMP dial to a higher number
	The air filter is dirty	<ul style="list-style-type: none"> Clean the filter. See the Cleaning and Care Section of the manual.
	The room may be too warm	<ul style="list-style-type: none"> Please allow time for the room to cool down after turning on the air conditioner.
	Cold air is escaping	<ul style="list-style-type: none"> Check for open furnace registers and cold air returns
	The cooling coils are frozen	<ul style="list-style-type: none"> See "Air Conditioner Freezing Up" below.
The Air Conditioner is freezing up	Ice blocks the air flow and stops the air conditioner from cooling the room	<ul style="list-style-type: none"> Set the MODE dial to HIGH FAN or HIGH COOL and set the TEMP dial to 1 or 2
The Remote Control is not working (if included with your air conditioner)	The batteries are inserted incorrectly	<ul style="list-style-type: none"> Check the position of the batteries.
	The batteries may be dead	<ul style="list-style-type: none"> Replace the batteries

TROUBLESHOOTING (CONT.)

PROBLEM	POSSIBLE CAUSES	SOLUTIONS
Water is dripping outside	Hot and humid weather.	<ul style="list-style-type: none">• This is normal
Water is dripping inside the room	The air conditioner is not correctly tilted outside.	<ul style="list-style-type: none">• For proper water drainage, make sure the air conditioner is slightly tilted downward from the front of the unit to the rear.
Water collects in the base pan	Moisture removed from the air is draining into the base pan.	<ul style="list-style-type: none">• This is normal for a short period in areas with low humidity and normal for a longer period in areas with high humidity.

CONSERVATOR®

Your air conditioner is covered by a limited warranty provided by Crosley Corporation. Crosley has authorized CrosleyCare authorized servicers to perform the service under this warranty. Crosley authorizes no one else to change or add to any of these obligations under this limited warranty. Any obligations for service and parts under this limited warranty must be performed by an authorized CrosleyCare servicer. For one year from your original date of purchase, Crosley will pay all costs for repairing or replacing any parts of this appliance that prove to be defective in materials or workmanship when such appliance is installed, used and maintained in accordance with the provided instructions.

Please see warranty information packed with product or ask the dealer for complete warranty details.

Exclusions – This limited warranty does not cover the following:

1. Products with original serial numbers that have been removed, altered or cannot be readily determined.
2. Product that has been transferred from its original owner to another party or removed outside the USA.
3. Rust on the interior or exterior of the unit.
4. Products purchased "as-is".
5. Removal and/or installation of the product to provide service.
6. Products used in a commercial setting.
7. Service calls which do not involve malfunction or defects in materials or workmanship, or for appliances not in ordinary household use or used other than in accordance with the provided instructions.
8. Service calls to correct the installation of your appliance or to instruct you how to use your appliance.
9. Expenses for making the appliance accessible for servicing, such as removal of trim, cupboards, shelves, etc., which are not a part of the appliance when it is shipped from the factory.
10. Service calls to repair or replace appliance light bulbs, air filters, water filters, other consumables, or knobs, handles, or other cosmetic parts.
11. Surcharges including, but not limited to, any after hour, weekend, or holiday service calls, tolls, ferry trip charges, or mileage expense for service calls to remote areas, including the state of Alaska.
12. Damages to the finish of appliance or home incurred during installation, including but not limited to floors, cabinets, walls, etc.
13. Damages caused by: services performed by unauthorized service companies; use of parts other than genuine Crosley parts or parts obtained from persons other than authorized service companies; or external causes such as abuse, misuse, inadequate power supply, accidents, fires, or acts of God.

DISCLAIMER OF IMPLIED WARRANTIES; LIMITATION OF REMEDIES

CUSTOMER'S SOLE AND EXCLUSIVE REMEDY UNDER THIS LIMITED WARRANTY SHALL BE PRODUCT REPAIR OR REPLACEMENT AS PROVIDED HEREIN. CLAIMS BASED ON IMPLIED WARRANTIES, INCLUDING WARRANTIES OF MERCHANTABILITY OR FITNESS FOR A PARTICULAR PURPOSE, ARE LIMITED TO ONE YEAR OR THE SHORTEST PERIOD ALLOWED BY LAW, BUT NOT LESS THAN ONE YEAR. CROSLY SHALL NOT BE LIABLE FOR CONSEQUENTIAL OR INCIDENTAL DAMAGES SUCH AS PROPERTY DAMAGE AND INCIDENTAL EXPENSES RESULTING FROM ANY BREACH OF THIS WRITTEN LIMITED WARRANTY OR ANY IMPLIED WARRANTY. SOME STATES AND PROVINCES DO NOT ALLOW THE EXCLUSION OR LIMITATION OF INCIDENTAL OR CONSEQUENTIAL DAMAGES, OR LIMITATIONS ON THE DURATION OF IMPLIED WARRANTIES, SO THESE LIMITATIONS OR EXCLUSIONS MAY NOT APPLY TO YOU. THIS WRITTEN WARRANTY GIVES YOU SPECIFIC LEGAL RIGHTS. YOU MAY ALSO HAVE OTHER RIGHTS THAT VARY FROM STATE TO STATE.

If You Need Service

Keep your receipt, delivery slip, or some other appropriate payment record to establish the warranty period should service be required. If service is performed, it is in your best interest to obtain and keep all receipts. Service under this warranty must be obtained by contacting CrosleyCare at the addresses or phone numbers below. This warranty only applies in the USA. Your appliance is warranted by Crosley / CrosleyCare. Crosley authorizes no person to change or add to any obligations under this warranty. Obligations for service and parts under this warranty must be performed by CrosleyCare or an authorized service company. Product features or specifications as described or illustrated are subject to change without notice.

For service contact:

CrosleyCare Service
1-844-CROSLY (276-7539)
3 Sperry Road
Fairfield, NJ 07004

CONSERVATOR®

www.conservatorappliances.com