

CONSERVATOR®

USE & CARE GUIDE

8,000 BTU

Window Air Conditioner



INTRODUCTION

IMPORTANT SAFETY INSTRUCTION	1
ELECTRICAL REQUIREMENTS	3
PACKING LIST	4
INSTALLATION&ASSEMBLY INSTRUCTIONS	5
USING YOUR AIR CONDITIONER	12
OPERATING YOUR AIR CONDITIONER	14
CARE AND CLEANING	15
TROUBLESHOOTING	16

IMPORTANT SAFETY INSTRUCTIONS

Before installing and using your air conditioner, please read this owner's manual carefully. Store this manual in a safe place for future reference. Your safety and the safety of others is very important to us. Please pay attention to all safety messages outlined in this owner's manual.

WARNING: To reduce the risk of fire, electrical shock or injury when using your air conditioner, follow the following basic precautions:

- Plug into a grounded 3 prong outlet.
- Do not remove the ground prong.
- Do not use a plug adapter.
- Do not use an extension cord.
- Unplug the air conditioner before servicing
- Use two or more people to move and install the air conditioner



This is a safety alert symbol.

This symbol alerts you to potential hazards that can harm you or others or even cause death.

All safety messages will directly follow the safety alert symbol and/or the words "DANGER" or "WARNING".

⚠ DANGER

⚠ WARNING

Failure to immediately follow these instructions may cause serious injury or even death.

All Safety messages alert you of potential hazards, how to reduce the chance of injury, and what can happen if instructions are not followed correctly.

INTRODUCTION TO REFRIGERANTS R32

The refrigerants used for air conditioners are environmentally friendly hydrocarbons R32. This kind of erant is combustibile and odorless. Moreover, it can burn and explode under certain condition. However, there will be no risk of burning and explosion if you comply with the following table to install your air conditioner in a room with an appropriate area and use it correctly.

Compared with ordinary refrigerants, Refrigerant R32 is environmentally friendly and do not destroy the ozone sphere and that its value of greenhouse effect is also very low.

Room area requests for air conditioner with Refrigerant R32

Refrigerant	Capacity(Btu)	Room Area
R32	≤9K	Above 4m ²
	≤12K	Above 4m ²
	≤18K	Above 15m ²
	≤24K	Above 25m ²

Warnings

- Please read the manual before installation, using, maintenance.
- Do not use means to accelerate the defrosting process or to clean, other than those recommended by the manufacturer.
- Do not pierce or burn the appliance.
- The appliance shall be stored in a room without continuously operating sources (for example: open flames, an operating ignition gas appliance or an operating electric heater.)
- Please contact the nearest after-sale service center when maintenance is necessary. At the time of maintenance, the maintenance personnel must strictly comply with the Operation Manual provided by the corresponding manufacturer and any non-professional is prohibited to maintain the air conditioner.
- The handling, installation, storage, servicing and disposal must comply with the provisions of gas-related national laws and regulations, and also national wiring regulation.
- It is necessary to clear away the refrigerant in the system when maintaining or scrapping an air conditioner. Be aware that refrigerants may not contain an odour.

This appliance is not intended for use by persons (including children) with reduced physical, sensory or mental capabilities, or supervision or instruction concerning use of the appliance by a person responsible for their safety.

Children should be supervised to ensure that they do not play with the appliance.

Unit operation limits: Outdoor side 61~110°F, 80%RH; indoor side 61~90°F, 80%RH.



ELECTRICAL REQUIREMENTS

⚠ WARNING



Electrical Shock Hazard

Plug into a grounded 3 prong outlet.
 Do not remove the ground prong.
 Do not use an adapter
 Do not use an extension cord.
 Failure to follow these instructions can result in death, fire, or electrical shock

The electrical ratings for your air conditioner are listed on the model and serial number label located on the front left side of the unit (when facing the front).

Specific electrical requirements are listed in the chart below. Follow the requirements below for the type of plug on the power supply cord.

Wiring Requirements	Power Supply Cord
<ul style="list-style-type: none"> 115 volt (103 min.—127 max) (6K-8K) 0-8 amps (10K-12K) 0-12 amps (6K-8K) 10-amp time-delay fuse or circuit breaker (10K-12K) 15-amp time-delay fuse or circuit breaker Use on single outlet circuit only 	

Recommended Ground Method

For your personal safety, this air conditioner must be grounded. This air conditioner is equipped with a 3 prong power supply cord with a grounded plug. To minimize the possibility of electrical shock, the cord must be plugged into a 3 prong outlet and grounded in accordance with all local codes and ordinances. If a 3 prong outlet is not available, it is the customer's responsibility to have a properly grounded 3 prong outlet installed by a qualified electrician.

It is the customer's responsibility:

- To contact a qualified electrician
- To assure that the electrical installation is adequate and in conformance with the National Electrical Code, ANSI/NFPA 70 - latest edition, and all local codes and ordinances.

Copies of the standards listed may be obtained from:

National Fire Protection Association
 One Batterymarch Park
 Quincy, Massachusetts 02269

LCDI Power Cord and Plug

This air conditioner is equipped with an LCDI (Leakage Current Detection and Interruption) power cord that is required by UL. This power supply cord contains state-of-the-art electronics that sense leakage current. If the cord is damaged and leakage occurs, power will be disconnected from the unit.

The test and reset buttons on the LCDI Plug are used to check if the plug is functioning properly. To test the plug:

1. Plug power cord into a grounded 3 prong outlet
2. Press RESET (on some units a green light will turn on).
3. Press the TEST Button, the circuit should trip and cut all power to the air conditioner (on some units a green light may turn off).
4. Press the RESET button for use. You will hear a click and the A/C is not ready for use.







NOTES:

- The RESET button must be engaged for proper use.
- The power supply cord must be replaced if it fails to trip when the TEST button is pressed and the unit fails to reset.
- Do not use the power supply cord as an ON/OFF switch. The power supply cord is designed as a protection device.
- A damaged power supply cord must be replaced with a new power supply cord.
- The power supply cord contains new user serviceable parts. Opening the tamper-resistant case voids all warranty and performance claims.

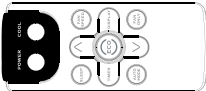
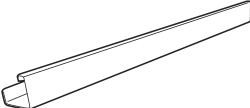

NOTE: Your units power cord and plug may differ from the one shown.

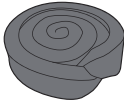
PACKING LIST

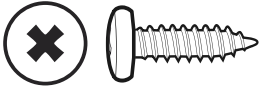
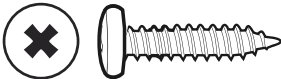
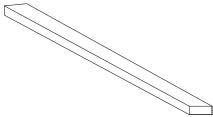
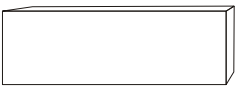
IMAGE	PART	QUANTITY
	Window Air Conditioner	1
	Remote Control	1
	Top Mounting Rail (With sponge)	1
	Lock Frame	2
	Filler Panels (With "Left" & "Right" remark on the front face)	2
	Sash Lock(Two holes)	1
	Window Sash Seal (Sponge)	1
	3/8" Screws	4
	1/2" Screws	3
	3/4" Screws	4
	Foam Top Window Gasket (Thin sponge for back-up using)	1
	Insulation strip(Sponge)	2

DISCLAIMER

ALL INFORMATION AND THE TECHNICAL SPECIFICATIONS PRESENTED IN THIS USER'S MANUAL ARE THE PRESENTATION OF THE MANUFACTURER.

INSTALLATION & ASSEMBLY INSTRUCTIONS (USED FOR 6K/8K)

Some assembly is required for your new air conditioner. Please read and follow these instructions carefully.

1. This air conditioner is designed to be installed in a standard double-hung window with a window width between 23" and 36" (584 mm - 914 mm).
2. The air conditioner can be installed without the accordion panels to fit in a narrow window opening. See the window dimensions.
3. The Lower Sash (the lower part of the window that moves up and down) must allow for 14.5" of vertical clearance when open. (See FIG. 1).
4. All supporting parts must be secured to firm wood, masonry, or metal.
5. The electrical outlet must be within reach of the power cord.

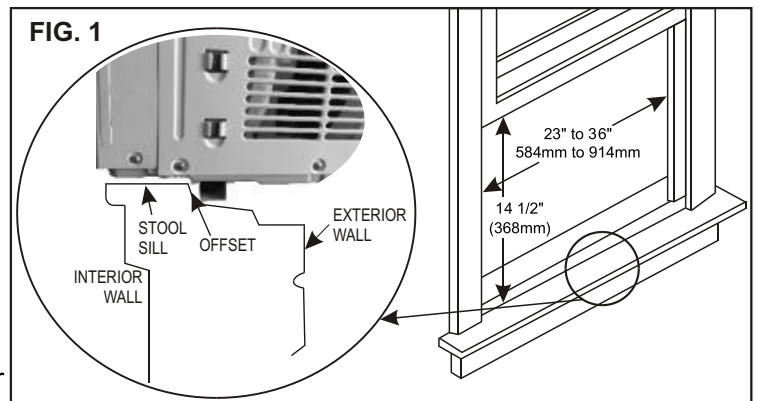

NOTE: Save the product packaging and installation instructions for future reference. Store the air conditioner in the product box when not in use for an extended period of time.

INSTALLATION & ASSEMBLY INSTRUCTIONS (USED FOR 10K/12K)

Some assembly is required for your new air conditioner. Please read and follow these instructions carefully.

1. This air conditioner is designed to be installed in a standard double-hung window with a window width between 26" and 36" (660 mm - 914 mm).
2. The air conditioner can be installed without the accordion panels to fit in a narrow window opening. See the window dimensions.
3. The Lower Sash (the lower part of the window that moves up and down) must allow for 16" of vertical clearance when open. (See FIG. 2).
4. All supporting parts must be secured to firm wood, masonry, or metal.
5. The electrical outlet must be within reach of the power cord.

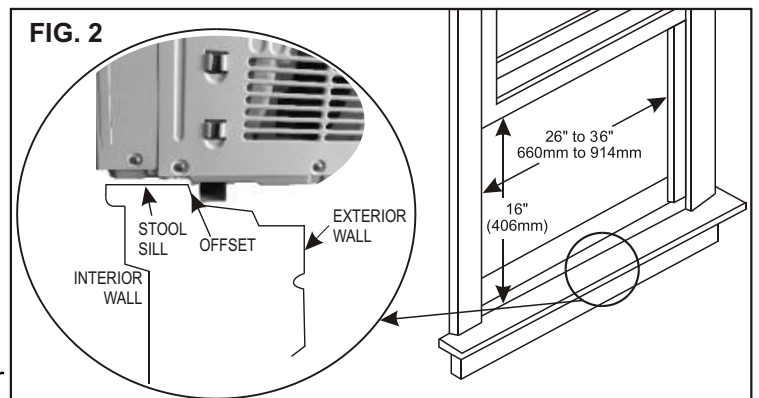



NOTE: Save the product packaging and installation instructions for future reference. Store the air conditioner in the product box when not in use for an extended period of time.

Top Rail Assembly (Only used for 6K/8K)

The top rail must be assembled prior to installing the air conditioner in the window

Tools Needed: Phillips Screw Driver

Top Rail Hardware		QTY
	3/8" Screw	4
	Top Rail	1

Attaching the Top Rail to the Air Conditioner

1. Remove the air conditioner from the box and place on a hard flat surface.
2. Remove top rail from the bottom of the packaging material as shown in FIG. A
3. Align the hole in the top rail with those in the top of the unit as shown in FIG. B
4. Secure the top rail to the unit with the 3/8" Screws as shown in FIG. C

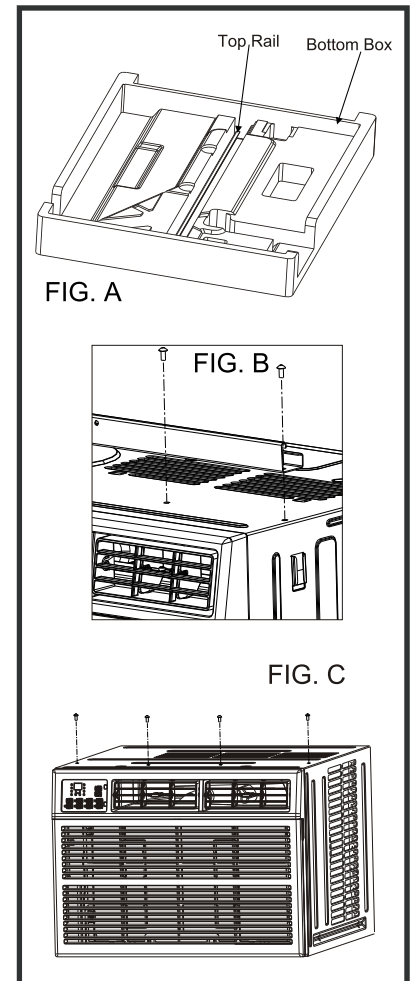

NOTE: For safety reasons, all 4 screws must be used to attach the top rail.

CAUTION

When handling the unit, be careful to avoid cuts from the sharp metal edges and aluminum fins on the front and rear coils.

MOUNTING HARDWARE



3/4" Screws

Qty

4

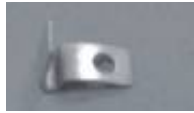

Lock Frame

2



Sash Lock

1

TOOLS NEEDED:

- Phillips Screw Driver
- Drill (If pilot holes are needed)

CAUTION

When handling unit, be careful to avoid cuts from sharp metal edges and aluminum fins on front and rear coils.

How to Install

NOTE: Top Rail and Sliding Panels at each side are offset to provide the proper pitch to the rear of (5/16"). This is necessary for proper condensed water utilization and drainage. If you are not using the Side Panels for any reason, this pitch to the rear must be maintained!

1

Place unit on floor, a bench or a table. There is a Left and Right Window Filler Panel - be sure to use the proper panel for each side. When installed the flange for securing the panel in place to the window sill will be facing into the room.

A. Hold the Accordion Panel in one hand and gently pull back the center to free the open end. See Figure 3.

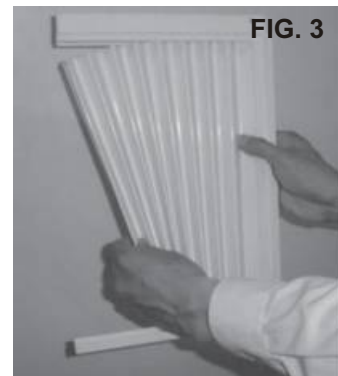

FIG. 3

B. Slide the free end of the panel into the cabinet as shown in Figures 4. Slide the panel down. Be sure to leave enough space to slip the top and bottom of the frame into the rails on the cabinet.

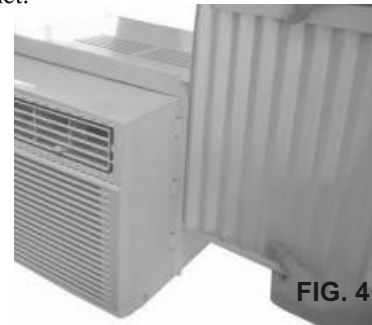

FIG. 4

C. Once the panel has been installed on the side of the cabinet, make sure it sits securely inside the frame channel by making slight adjustments. Slide the top and bottom ends of the frame into the top and bottom rails of the cabinet. Figure 5.



FIG. 5

D. Slide the panel all the way in and repeat on the other side.

2 Keep a firm grip on the air conditioner, carefully place the unit into the window opening so the bottom of the air conditioner frame is against the window sill (FIG. 6). Carefully close the window behind the top rail of the unit. **(Suggest to keep a downward oblique, to let accumulated rain water to drain out, from back side of the unit bottom.)**



3 Extend the side panels out against the window frame (FIG. 7).



4 Place the frame lock between the frame extensions and the window sill as shown (Fig. 8). Drive 3/4" (19 mm) locking screws through the frame lock and into the sill (FIG. 9). **NOTE:** To prevent window sill from splitting, drill 1/8" (3 mm) pilot holes before driving screws.



5 Drive 1/2" (12.7mm) locking screws through frame holes into window sash (FIG. 10/11).



6 To secure lower sash in place, attach right angle sash lock with 3/4" (19 mm) screw as shown (FIG. 12).



7 Cut foam seal and insert in the space between the upper and lower sashes (FIG. 13).

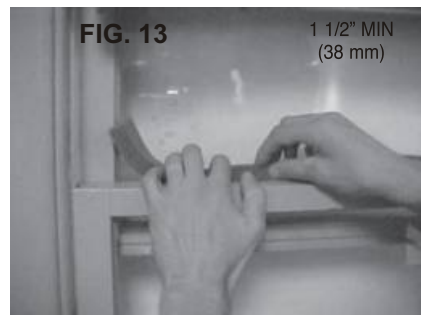

If AC is Blocked by Storm Window

Add wood as shown in FIG. 14, or remove storm window before air conditioner is installed.

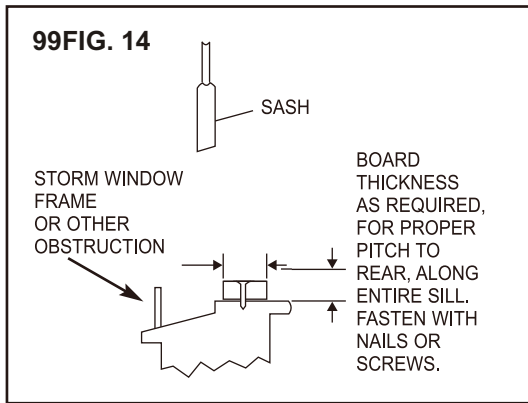

If Storm Window Frame must remain, be sure the drain holes or slots are not caulked or painted shut. Accumulated Rain Water or Condensation must be allowed to drain out.

Removing AC From Window

- * Turn AC off, and disconnect power cord.
- * Remove sash seal from between windows, and unscrew safety lock.
- * Remove screws installed through frame and frame lock.
- * Close (slide) side panels into frame.
- * Keeping a firm grip on air conditioner, raise sash and carefully “rock” air conditioner backward to drain any condensate water in base of unit. Be careful not to spill any remaining water while lifting unit from window. Store parts WITH air conditioner.

AIR CONDITIONER USE

Operating your air conditioner properly helps you to obtain the best possible results.

This section explains proper air conditioner operation.

IMPORTANT:

- If you turn off the air conditioner, wait at least 3 minutes before turning it back on. This prevents the air conditioner from blowing a fuse or tripping a circuit breaker.
- Do not try to operate your air conditioner in the cooling mode when outside temperature is below 65°F (18°C). The inside evaporator coil will freeze up, and the air conditioner will not operate properly.

NOTE: In the event of a power failure, your air conditioner will operate at the previous settings when the power is restored.

INSTALLATION & ASSEMBLY INSTRUCTIONS

Introduction to Refrigerants R32

- Before installing the appliance, you must read the manual carefully to get the safety information and notes.
- When filling the combustible refrigerant, any of your rude operations may cause serious injury or injuries to human body or bodies and object or objects.
- A leak test must be done after the installation is completed.
- It is a must to do the safety inspection before maintaining or repairing an air conditioner using combustible refrigerant in order to ensure that the fire risk is reduced to minimum.
- It is necessary to operate the machine under a controlled procedure in order to ensure that any risk arising from the combustible gas or vapor during the operation is reduced to minimum.
- Requirements for the total weight of filled refrigerant and the area of a room to be equipped with an air conditioner (are shown as in the following Tables GG.1 and GG.2)



The maximum charge and the required minimum floor area

$$m_1 = (4 \text{ m}^3) \times LFL, m_2 = (26 \text{ m}^3) \times LFL, m_3 = (130 \text{ m}^3) \times LFL$$

Where LFL is the lower flammable limit in kg/m^3 , R32 LFL is 0.306 kg/m^3 .

For the appliances with a charge amount $m_1 < M \leq m_2$:

The maximum charge in a room shall be in accordance with the following: $m_{\max} = 2.5 \times (LFL)^{(5/4)} \times h_0 \times (A)^{1/2}$

The required minimum floor area A_{\min} to install an appliance with refrigerant charge M (kg)

shall be in accordance with following: $A_{\min} = (M / (2.5 \times (LFL)^{(5/4)} \times h_0))^2$

Where:

m_{\max} is the allowable maximum charge in a room, in kg;

M is the refrigerant charge amount in appliance, in kg;

A_{\min} is the required minimum room area, in m^2 ;

A is the room area, in m^2 ;

LFL is the lower flammable limit, in kg/m^3 ;

h_0 is the installation height of the appliance, in meters for calculating m_{\max} or A_{\min} , 1.8 m for wall mounted;

Table GG.1 Maximum charge (kg)

Category	LFL (kg/m^3)	h_0 (m)	Floor area(m^2)						
			4	7	10	15	20	30	50
R32	0.306	0.6	0.68	0.9	1.08	1.32	1.53	1.87	2.41
		1	1.14	1.51	1.8	2.2	2.54	3.12	4.02
		1.8	2.05	2.71	3.24	3.97	4.58	5.61	7.254
		2.2	2.5	3.31	3.96	4.85	5.6	6.86	8.85

Table GG.2 Minimum room area (m^2)

Category	LFL (kg/m^3)	h_0 (m)	Charge amount (M) (kg)						
			Minimum room area(m^2)						
R32	0.306		1.224 kg	1.836 kg	2.448 kg	3.672 kg	4.896 kg	6.12 kg	7.956 kg
		0.6		29	51	116	206	321	543
		1		10	19	42	74	116	196
		1.8		3	6	13	23	36	60
		2.2		2	4	9	15	24	40

INSTALLATION & ASSEMBLY INSTRUCTIONS

Introduction to Refrigerants R32

1. Site Safety



Open Flames Prohibited



Ventilation Necessary

2. Operation Safety

Open Flames Prohibited



Mind Static Electricity



Must Wear Protective Clothing and anti-static gloves



Don't use mobile phone

3. Installation Safety

- Refrigerant Leak Detector
- Appropriate Installation Location



The left picture is the schematic diagram of a refrigerant leak detector.

Please note that:

1. The installation site should be in a well-ventilated condition.
2. The sites for installing and maintaining an air conditioner using Refrigerant R32 should be free from open fire or welding, smoking, drying oven or any other heat source higher than 548°C which easily produces open fire.
3. When installing an air conditioner, it is necessary to take appropriate anti-static measures such as wear anti-static clothing and/or gloves.
4. It is necessary to choose the site convenient for installation or maintenance wherein the air inlets and outlets of the indoor and outdoor units should be not surrounded by obstacles or close to any heat source or combustible and/or explosive environment.
5. If the indoor unit suffers refrigerant leak during the installation, all the personnel should go out till the refrigerant leaks completely for 15 minutes. If the product is damaged, it is a must to carry such damaged product back to the maintenance station and it is prohibited to weld the refrigerant pipe or conduct other operations on the user's site.
6. It is necessary to choose the place where the inlet and outlet air of the indoor unit is even.
7. It is necessary to avoid the places where there are other electrical products, power switch plugs and sockets, kitchen cabinet, bed, sofa and other valuables right under the lines on two sides of the indoor unit, and also prevent mechanical damage from occurring.

USING YOUR AIR CONDITIONER

Electronic Control Panel & Remote Control

NOTE: This display always shows the room temperature in Fan Mode except when setting the Set temperature or the Timer.

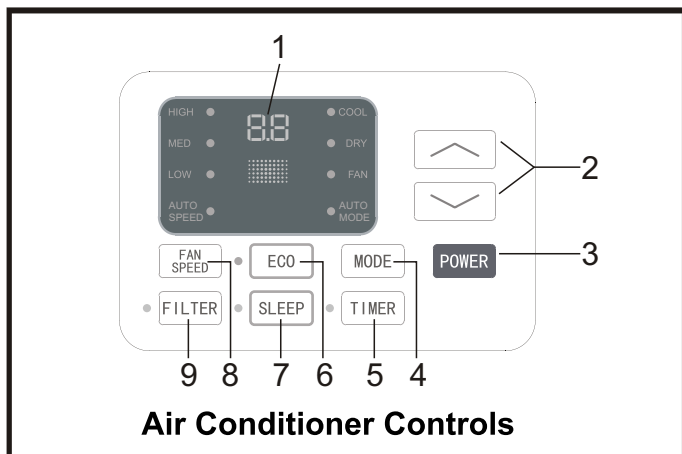

Normal Operating Sounds

- You may hear a pinging noise caused by water hitting the condenser, on rainy days, or when the humidity is high. This design feature helps remove moisture and improve efficiency.
- You may hear the thermostat click when the compressor cycles on and off.
- Water will collect in the base pan during rain or days of high humidity. The water may overflow and drip from the outside part of the unit.
- The fan may run even when the compressor is not on.

- Digital Display:** Without timer setting, the operation mode is Cooling, Dry, Fan and Auto, and the set temperature will be displayed. Time will be displayed under timer setting.
- ^ and v Button:** Use these buttons on the control panel and remote to increase or decrease the Set Temperature or Timer. Temperature range: 61°F~88°F or 16°C~31°C.
- Power Button:** Turn the air conditioner on and off.
- Mode Button:** Press the mode button to cycle through the various modes: Cool, Dry, Fan and Auto.

Cool Mode: The cooling function allows the air conditioner to cool the room and at the same time reduces Air humidity. Press the MODE button to activate the cooling function. To optimize the function of the air conditioner, adjust the temperature and the speed by pressing the button indicated.

Dry Mode: This function reduces the humidity of the air to make the room more comfortable. Press MODE button to set the DRY mode. An automatic function of alternating cooling cycles and air fan is activated.

Fan Mode: The conditioner works in only ventilation. Press MODE button to set the FAN mode. With pressing FAN SPEED button the speed changes in the following sequence: Hi, Med and Lo in FAN mode. The remote control also stores the speed that was set in the previous mode of operation.

Auto Mode: In AUTO mode the unit automatically chooses the fan speed and the mode of operation (COOL, DRY or FAN). In this mode the fan speed and the temperature are set automatically according to the room temperature (tested by the temperature sensor which is incorporated in the indoor unit.).

- Timer Button:** Use these buttons on the control panel and remote to set the Timer.

Timer Off: The timed stop is programmed by pressing TIMER button. Set the rest time by pressing the button “^” or “v” until the rest time displayed is to your demand then press TIMER button again.

Timer On: When the unit is off, press TIMER button at the first time, set the temperature with pressing the button “^” or “v”. Press TIMER button at the second time, set the rest time with pressing the button “^” or “v”. Press TIMER button at the third time, confirm the setting, then the rest time to next automatical switching-on could be read on the display of the machine.

Note: It can be set to automatically turn off or on in 0.5-24 hours. Each press of the “^” “v” buttons will increase or decrease the timer. The Timer can be set in 0.5 hours increment below 10 hours and 1 hour increment for 10 hours or above. The SET light will turn on while setting. To cancel the setted function, press the TIMER button again.

USING YOUR AIR CONDITIONER

Electronic Control Panel & Remote Control

6. **Eco Button:** When the unit is in ECO mode, the light will turn on. In ECO mode, the unit will turn off once the room is cooled to the user-set temperature.
The unit will turn back on when the room temperature rises above the user-set temperature. Before the compressor starts, the fan motor will run for a while, then it will stop for a while, and will repeat to provide a much more comfortable feeling and save energy.
7. **Sleep Button:** Press the SLEEP button, all of the display lights will turn off after a while, but the Sleep light is always on. In SLEEP mode, the air conditioner will automatically adjust the temperature and fan speed to make the room more comfortable during the night. The set temperature will automatically raise every 30-60 minutes, and at most change six times until the set temperature is 81 or 82°F.
8. **Fan Speed Button:** Press the FAN SPEED button to choose the fan speed options. You can choose Hi, Med, Lo or auto speed in COOL mode and choose Hi, Med, Lo in FAN mode.
9. **Filter Button:** When the Filter Check light is off, it is not necessary to press the Filter Check button. When the Filter Check light is on, you can turn off the light by pressing the Filter Check button. After the fan motor works for 500 total hours, the Filter Check light will turn on to remind the user to clean the filter.

10. **Directional Louvers:** To direct the airflow, use the horizontal wheel to control the horizontal direction, and use the air deflectors to control the vertical direction.

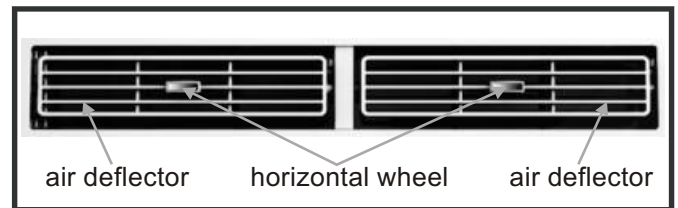

OPERATING YOUR AIR CONDITIONER

REMOTE CONTROL

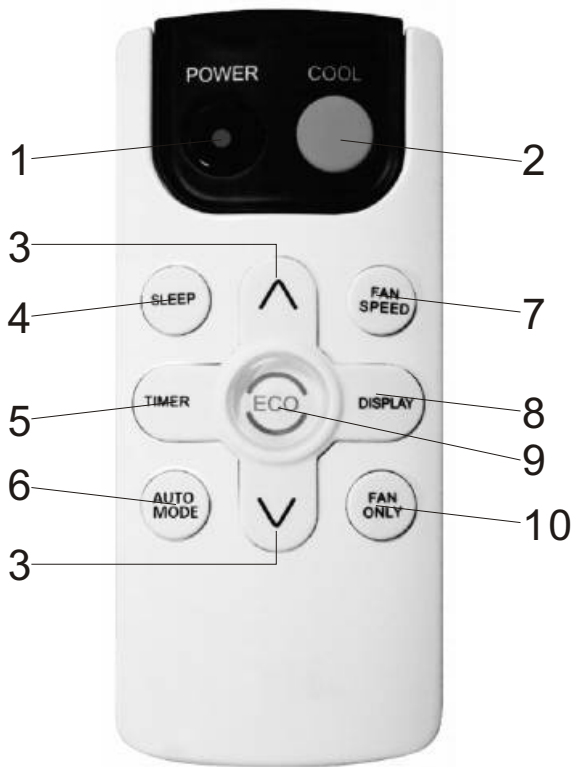

1. **Power:** Turn the air conditioner on and off.
2. **Cool:** Press the COOL button to COOL mode.
3. **^ and v:** Use these buttons on the control panel and remote to increase or decrease the Set Temperature or Timer. Temperature range: 61°F~88°F or 16°C~31°C.
4. **Sleep:** Press the SLEEP button, all of the display lights will turn off after a while, but the Sleep light is always on. In SLEEP mode, the air-conditioner will automatically adjust the temperature and fan speed to make the room more comfortable during the night. The set temperature will automatically raise every 30-60 minutes and at most change six times until the set temperature is 81 or 82°F.
5. **Timer:** Use these buttons on the control panel and remote to set the Timer.
Timer Off: The timed stop is programmed by pressing TIMER button. Set the rest time by pressing the button “^” or “v” until the rest time displayed is to your demand then press TIMER button again.
Timer On: When the unit is off, press TIMER button at the first time, set the temperature with pressing the button or “^”. Press “v” TIMER button at the second time, set the rest time with pressing the button or “^”. Press “v” TIMER button at the third time, confirm the setting, then the rest time to next automatical switching-on could be read on the display of the machine.
Note: It can be set to automatically turn off or on in 0.5-24 hours. Each press of the “^” “v” buttons will increase or decrease the timer. The Timer can be set in 0.5 hours increment below 10 hours and 1 hour increment for 10 hours or above. The SET light will turn on while setting. To cancel the set function, press the TIMER button again.
6. **Auto Mode:** In AUTO mode the unit automatically chooses the mode of operation(COOL, DRY or FAN). In this mode the temperature will be set automatically according to the room temperature (tested by the temperature sensor which is incorporated in the indoor unit.).
7. **Fan Speed:** Press the FAN SPEED button to choose the fan speed options. You can choose Hi, Med, Lo or auto speed in COOL mode and choose Hi, Med, Lo in FAN mode.
8. **Display:** To press the DISPLAY button, it can switch off/on all lights or LED display.
9. **Eco:** When the unit is in ECO mode, the light will turn on. In ECO mode, the unit will turn off once the room is cooled to the user set temperature. The unit will turn back on when the room temperature rises above the user set temperature. Before the compressor starts, the fan motor will run for a while, then it will stop for a while, and will repeat to provide a much more comfortable feeling and save energy.
10. **Fan Only:** Press the Fan Only button to FAN ONLY mode.

Battery Size: AAA - NOTE: Do not mix old and new batteries or different types of AAA batteries.

CARE AND CLEANING

Clean your air conditioner to keep it looking new and to minimize dust build up.

Air Filter Cleaning

The air filter should be checked at least once every month to see if it needs cleaning. Trapped particles and dust can build up in the filter and may decrease airflow as well as cause the cooling coils to accumulate frost. To clean the air filter:

1. Remove the filter by pulling down on the indents of the filter door on the front of the unit. (See FIG. 15)
2. Wash the filter using liquid dish soap and warm water. Rinse the filter thoroughly. Gently shake the filter to remove excess water.
3. Let the filter dry completely before placing it into the air conditioner.
4. If you do not wish to wash the filter, you may vacuum the filter to remove the dust and other particles.

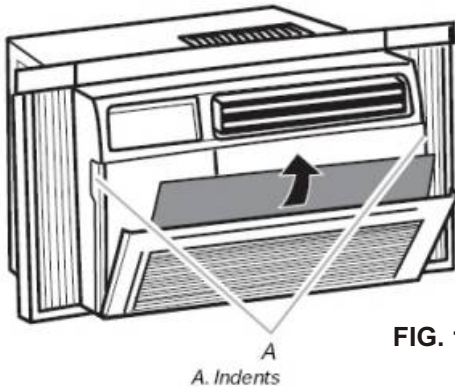

FIG. 15

Wear and Tear

To minimize wear and tear on the air conditioner, always wait at least 3 minutes before changing modes. This will help prevent the compressor from overheating and the circuit breaker from tripping.

Cabinet Cleaning

To clean the air conditioner cabinet:

- Unplug the air conditioner to prevent shock or a fire hazard. The cabinet and front panel of the air conditioner may be dusted with an oil-free cloth or washed with a cloth dampened in a solution of warm water and mild liquid soap. Rinse thoroughly with a damp cloth and wipe dry.
- Never use harsh cleaners, wax or polish on the cabinet front.
- Be sure to wring excess water from the cloth before wiping around the controls. Excess water in or around the controls may cause damage to the air conditioner.

Winter Storage

To store the air conditioner when it is not in use for an extended period of time, remove it carefully from the window according to the installation instructions and cover it with plastic or place it in the original box.

TROUBLESHOOTING

PROBLEM	POSSIBLE CAUSES	SOLUTIONS
The Air Conditioner will not start	The air conditioner is unplugged	<ul style="list-style-type: none"> Make sure the air conditioner plug is pushed completely into the outlet
	The fuse is blown/circuit breaker is tripped.	<ul style="list-style-type: none"> Check the house fuse/circuit breaker box and replace the fuse or reset the breaker.
	Power failure	<ul style="list-style-type: none"> The unit will automatically re-start when power is restored. There is a protective time delay (approx. 3 minutes) to prevent tripping of the compressor overload. For this reason, the unit may not start normal cooling for 3 minutes after it is turned back on.
	The current interrupter device is tripped.	<ul style="list-style-type: none"> Press the RESET button located on the power cord plug. If the RESET button will not stay engaged, discontinue use of the air conditioner and contact a qualified service technician.
The Air Conditioner does not cool as it should	Airflow is restricted	<ul style="list-style-type: none"> Make sure there are no curtains, blinds, or furniture blocking the front of the air conditioner
	The temperature control may not be set correctly.	<ul style="list-style-type: none"> Lower the set thermostat temperature
	The air filter is dirty	<ul style="list-style-type: none"> Clean the filter. See the Cleaning and Care Section of the manual.
	The room may be too warm	<ul style="list-style-type: none"> Please allow time for the room to cool down after turning on the air conditioner.
	Cold air is escaping	<ul style="list-style-type: none"> Check for open furnace registers and cold air returns
	The cooling coils are frozen	<ul style="list-style-type: none"> See "Air Conditioner Freezing Up" below.
The Air Conditioner is freezing up	Ice blocks the air flow and stops the air conditioner from cooling the room	<ul style="list-style-type: none"> Set the MODE dial to HIGH FAN or HIGH COOL and set the thermostat to a higher temperature
The Remote Control is not working	The batteries are inserted incorrectly	<ul style="list-style-type: none"> Check the position of the batteries.
	The batteries may be dead	<ul style="list-style-type: none"> Replace the batteries

TROUBLESHOOTING (CONT.)

PROBLEM	POSSIBLE CAUSES	SOLUTIONS
Water is dripping outside	Hot and humid weather.	<ul style="list-style-type: none">• This is normal
Water is dripping inside the room	The air conditioner is not correctly tilted outside.	<ul style="list-style-type: none">• For proper water drainage, make sure the air conditioner is slightly tilted downward from the front of the unit to the rear.
Water collects in the base pan	Moisture removed from the air is draining into the base pan.	<ul style="list-style-type: none">• This is normal for a short period in areas with low humidity and normal for a longer period in areas with high humidity.

CONSERVATOR®

Your air conditioner is covered by a limited warranty provided by The Crosley Group, Inc. Crosley has authorized CrosleyCare authorized servicers to perform the service under this warranty. Crosley authorizes no one else to change or add to any of these obligations under this limited warranty. Any obligations for service and parts under this limited warranty must be performed by an authorized CrosleyCare servicer. For one year from your original date of purchase, Crosley will pay all costs for repairing or replacing any parts of this appliance that prove to be defective in materials or workmanship when such appliance is installed, used and maintained in accordance with the provided instructions.

Please see warranty information packed with product or ask the dealer for complete limited warranty details.

Exclusions – This limited warranty does not cover the following:

1. Products with original serial numbers that have been removed, altered or cannot be readily determined.
2. Product that has been transferred from its original owner to another party or removed outside the USA.
3. Rust on the interior or exterior of the unit.
4. Products purchased "as-is".
5. Removal and/or installation of the product to provide service.
6. Products used in a commercial setting.
7. Service calls which do not involve malfunction or defects in materials or workmanship, or for appliances not in ordinary household use or used other than in accordance with the provided instructions.
8. Service calls to correct the installation of your appliance or to instruct you how to use your appliance.
9. Expenses for making the appliance accessible for servicing, such as removal of trim, cupboards, shelves, etc., which are not a part of the appliance when it is shipped from the factory.
10. Service calls to repair or replace appliance light bulbs, air filters, water filters, other consumables, or knobs, handles, or other cosmetic parts.
11. Surcharges including, but not limited to, any after hour, weekend, or holiday service calls, tolls, ferry trip charges, or mileage expense for service calls to remote areas, including the state of Alaska.
12. Damages to the finish of appliance or home incurred during installation, including but not limited to floors, cabinets, walls, etc.
13. Damages caused by: services performed by unauthorized service companies; use of parts other than genuine Crosley parts or parts obtained from persons other than authorized service companies; or external causes such as abuse, misuse, inadequate power supply, accidents, fires, or acts of God.

DISCLAIMER OF IMPLIED WARRANTIES; LIMITATION OF REMEDIES

CUSTOMER'S SOLE AND EXCLUSIVE REMEDY UNDER THIS LIMITED WARRANTY SHALL BE PRODUCT REPAIR OR REPLACEMENT AS PROVIDED HEREIN. CLAIMS BASED ON IMPLIED WARRANTIES, INCLUDING WARRANTIES OF MERCHANTABILITY OR FITNESS FOR A PARTICULAR PURPOSE, ARE LIMITED TO ONE YEAR OR THE SHORTEST PERIOD ALLOWED BY LAW, BUT NOT LESS THAN ONE YEAR. CROSLY SHALL NOT BE LIABLE FOR CONSEQUENTIAL OR INCIDENTAL DAMAGES SUCH AS PROPERTY DAMAGE AND INCIDENTAL EXPENSES RESULTING FROM ANY BREACH OF THIS WRITTEN LIMITED WARRANTY OR ANY IMPLIED WARRANTY. SOME STATES AND PROVINCES DO NOT ALLOW THE EXCLUSION OR LIMITATION OF INCIDENTAL OR CONSEQUENTIAL DAMAGES, OR LIMITATIONS ON THE DURATION OF IMPLIED WARRANTIES, SO THESE LIMITATIONS OR EXCLUSIONS MAY NOT APPLY TO YOU. THIS WRITTEN WARRANTY GIVES YOU SPECIFIC LEGAL RIGHTS. YOU MAY ALSO HAVE OTHER RIGHTS THAT VARY FROM STATE TO STATE.

If You Need Service

Keep your receipt, delivery slip, or some other appropriate payment record to establish the warranty period should service be required. If service is performed, it is in your best interest to obtain and keep all receipts.

Service under this warranty must be obtained by contacting CrosleyCare at the addresses or phone numbers below.

This warranty only applies in the USA. Your appliance is warranted by Crosley / CrosleyCare.

Crosley authorizes no person to change or add to any obligations under this warranty. Obligations for service and parts under this warranty must be performed by CrosleyCare or an authorized service company. Product features or specifications as described or illustrated are subject to change without notice.

For Service Contact:

CrosleyCare Service
1-844-CROSLLEY (276-7539)
3 Sperry Road
Fairfield, NJ 07004

www.conservatorappliances.com

For other information contact:

Crosley Extended Warranty
1-800-356-5268
11430 Gravois Rd
St. Louis, MO 63126

www.crosley.com